

GM5BW05340AC

Light Emitting Diode

Issue Date: Jan. 27, 2005

SHARP

SPEC. No.

ISSUE

Jan-27-05

ELECTRONIC COMPONENTS GROUP

SHARP CORPORATION

SPECIFICATION

DEVICE SPECIFICATION FOR
LIGHT EMITTING DIODE

MODEL No.

GM5BW05340AC

The appearance and specifications of the product may be modified for improvement without notice.

Reference

LED Business Development Center
Electronic Components Group
SHARP CORPORATION

Reference

PRODUCT NAME Light Emitting Diode
MODEL No. GM5BW05340AC

1. These specification sheets include materials protected under the copyright of Sharp Corporation ("Sharp"). Please do not reproduce or cause anyone to reproduce them without Sharp's consent.
2. When using this product, please observe the absolute maximum ratings and the instructions for use outlined in these specification sheets, as well as the precautions mentioned below. Sharp assumes no responsibility for any damage resulting from use of the product which does not comply with the absolute maximum ratings and the instructions included in these specification sheets, and the precautions mentioned below.

(Precautions)

- (1) This products is designed for use in the following application areas;

* OA equipment * Audio visual equipment * Home appliance
* Telecommunication equipment (Terminal) * Measuring equipment
* Tooling machines * Computers

If the use of the product in the above application areas is for equipment listed in paragraphs (2) or (3), please be sure to observe the precautions given in those respective paragraphs.

- (2) Appropriate measures, such as fail-safe design and redundant design considering the safety design of the overall system and equipment, should be taken to ensure reliability and safety when this product is used for equipment which demands high reliability and safety in function and precision, such as ;

* Transportation control and safety equipment (aircraft, train, automobile etc.)
* Traffic signals * Gas leakage sensor breakers * Rescue and security equipment
* Other safety equipment

- (3) Please do not use this product for equipment which require extremely high reliability and safety in function and precision, such as ;

* Space equipment * Telecommunication equipment (for trunk lines)
* Nuclear power control equipment * Medical equipment

- (4) Please contact and consult with a Sharp sales representative if there are any questions regarding interpretation of the above three paragraphs.

3. Please contact and consult with a Sharp sales representative for any questions about this product.

SHARP

Reference

GM5BW05340AC This technical literature

1. Application

This technical literature applies to the light emitting diode device Model No. GM5BW05340AC
[White (from InGaN Blue LED chip + Yellow Phosphor) LED device]

2. Outline dimensions and terminal connections ----- Refer to the attached sheet Page 3.

3. Ratings and characteristics ----- Refer to the attached sheet Page 4 ~ 6.

- 3-1. Absolute maximum ratings
- 3-2. Electro-optical characteristics
- 3-3. Derating Curve
- 3-4. Characteristics Diagram

SHARP

2. Outline dimensions and terminal connections

Reference

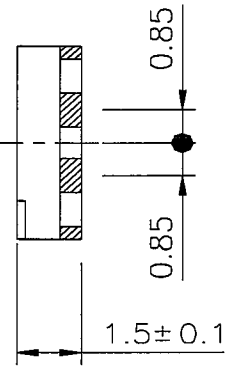
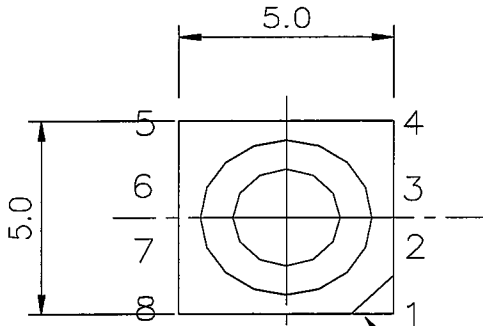

1Pin Mark

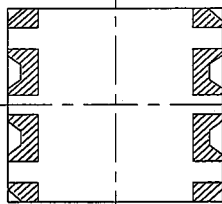
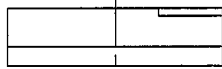

1.Pin Connection

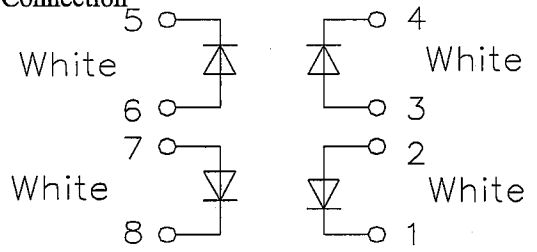

1 4 5 8: Cathode
2 3 6 7: Anode

2.Unspecified tolerance to be ± 0.3

3.Recommended soldering pattern

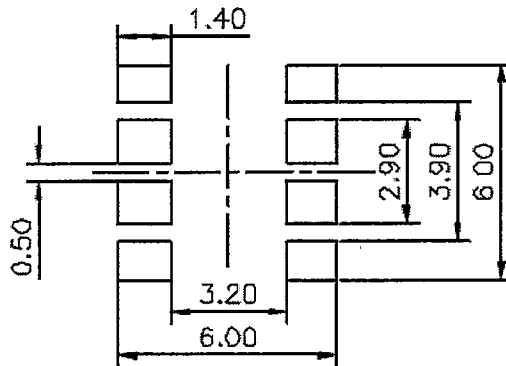

unit	Material	Finish	Drawing No.
m m	Substrate:Glass epoxy Package: Nylon + Silicone	Ag plate	

SHARP**Reference**

3. Ratings and characteristics

3-1. Absolute maximum ratings

(Ta=25 °C)

Parameter	Symbol	Rating	Unit
Power dissipation	P	140	mW
Continuous forward current (*1)	I _F	35	mA
Peak forward current(*2)	I _{FM}	(150)	mA
Derating factor	DC	0.58	mA/°C
	Pulse	1.88	mA/°C
Reverse voltage	V _R	5	V
Operating temperature	T _a	-30 to +85	°C
Storage temperature	T _{stg}	-40 to +100	°C
Soldering temperature (*3)	T _{sol}	290	°C

(*1) Rating of each chip. Using plural chips, within power dissipation.

(*2) Duty ratio = 1/10, Pulse width = 400ms

(*3) Manual soldering Max. 3 seconds. Refer to the 12 page of the reflow soldering profile.

3-2. Electro-optical characteristics

(Ta=25 °C)

Parameter	Symbol	Condition	MIN.	TYP.	MAX.	Unit
Forward Voltage(*4)	V _F	I _F =20 mA	—	3.4	4.0	V
Luminous intensity(*6) (4 chips light on)	I _V		8	10	—	cd
chromaticity(*4)	x		—	0.31	—	—
	y	—	0.31	—	—	
Reverse Current	I _R	V _R =4V	—	—	100	μA
Radiation pattern	2θ _{1/2}	I _F =20 mA	—	35	—	deg

(*4) Rating of each chip.

(*5) Measured by EG&G MODEL550(Radiometer/Photometersystem) after 20ms drive
(Tolerance : ±15%)(*6) Measured by Ohtsuka electronics MODEL MCPD-2000 after 20ms drive
(Tolerance : x,y:±0.02)

SHARP

3-3. Derating Curve

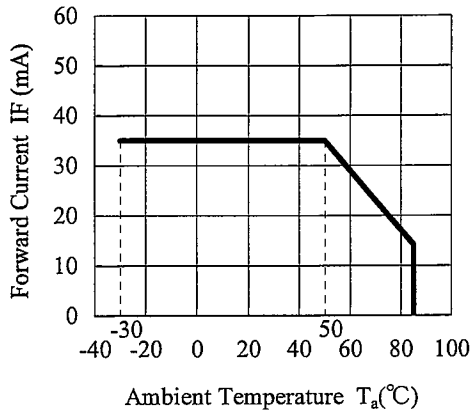

Forward Current Derating Curve
(4 chips light)

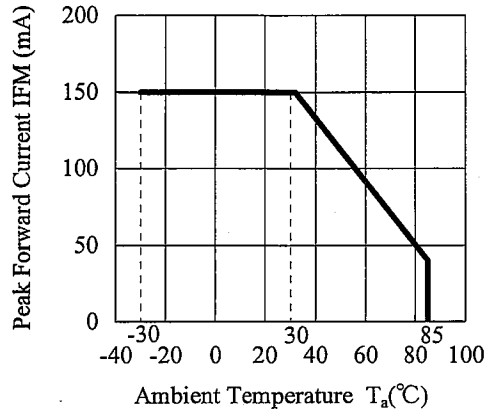

Peak Forward Current Derating Curve
(4 chips light)

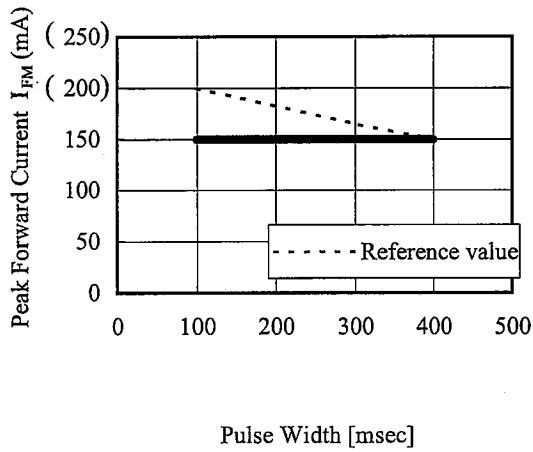

Peak Forward Current vs. Pulse Width ($T_a=25$ °C)
(4 chips light)

Reference

SHARP

Reference

3-4. Characteristic chart (Note)

Relative Luminous Intensity vs. Forward Current

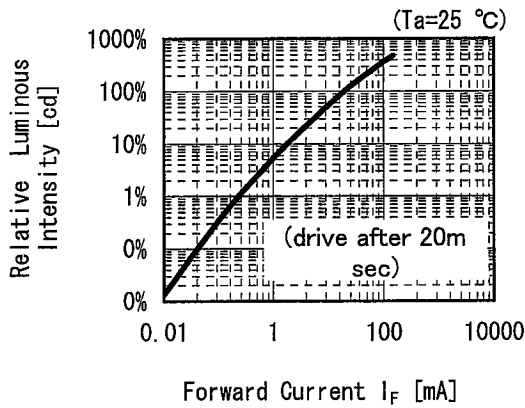

IF=20mA
(4 chips light on)

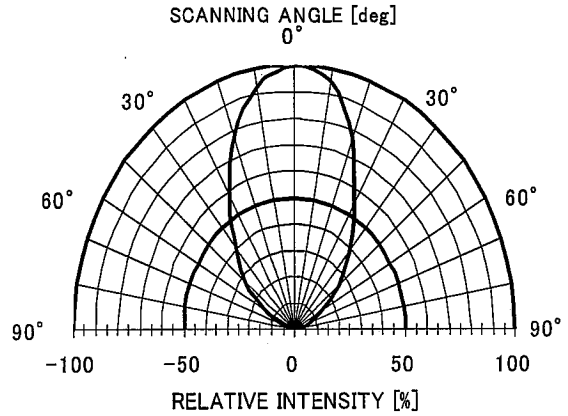

Forward Current vs. Forward Voltage

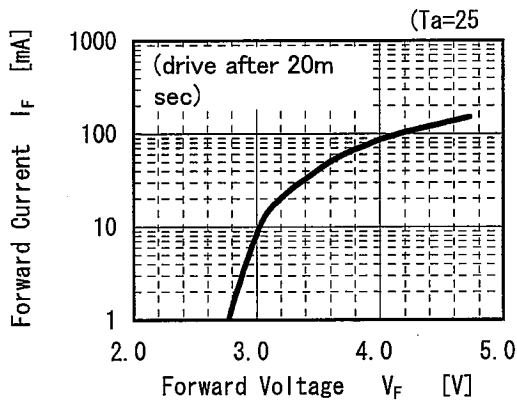

Illuminance vs. Forward Current

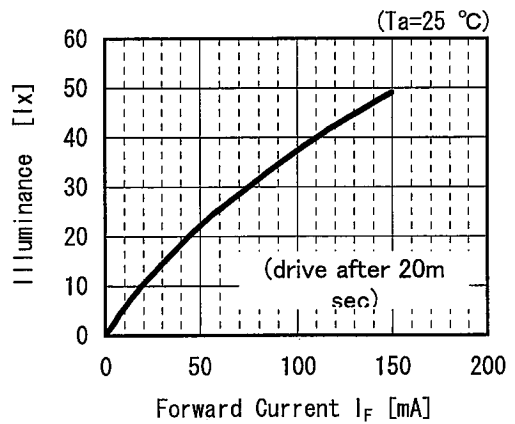

Forward Current vs. Chromaticity Coordinate

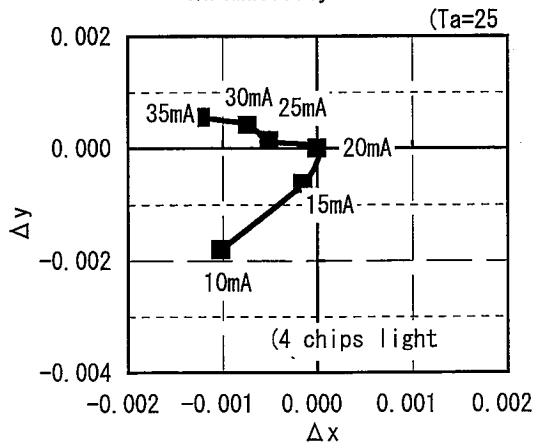

(Note) Above characteristic data are measurement data.

SPECIFICATIONS ARE SUBJECT TO CHANGE WITHOUT NOTICE.

Suggested applications (if any) are for standard use; See Important Restrictions for limitations on special applications. See Limited Warranty for SHARP's product warranty. The Limited Warranty is in lieu, and exclusive of, all other warranties, express or implied. ALL EXPRESS AND IMPLIED WARRANTIES, INCLUDING THE WARRANTIES OF MERCHANTABILITY, FITNESS FOR USE AND FITNESS FOR A PARTICULAR PURPOSE, ARE SPECIFICALLY EXCLUDED. In no event will SHARP be liable, or in any way responsible, for any incidental or consequential economic or property damage.

SHARP®

NORTH AMERICA

SHARP Microelectronics of the Americas
5700 NW Pacific Rim Blvd.
Camas, WA 98607, U.S.A.
Phone: (1) 360-834-2500
Fax: (1) 360-834-8903
Fast Info: (1) 800-833-9437
www.sharpsma.com

EUROPE

SHARP Microelectronics Europe
Division of Sharp Electronics (Europe) GmbH
Sonninstrasse 3
20097 Hamburg, Germany
Phone: (49) 40-2376-2286
Fax: (49) 40-2376-2232
www.sharpsme.com

JAPAN

SHARP Corporation
Electronic Components & Devices
22-22 Nagaike-cho, Abeno-Ku
Osaka 545-8522, Japan
Phone: (81) 6-6621-1221
Fax: (81) 6117-725300/6117-725301
www.sharp-world.com

TAIWAN

SHARP Electronic Components
(Taiwan) Corporation
8F-A, No. 16, Sec. 4, Nanking E. Rd.
Taipei, Taiwan, Republic of China
Phone: (886) 2-2577-7341
Fax: (886) 2-2577-7326/2-2577-7328

SINGAPORE

SHARP Electronics (Singapore) PTE., Ltd.
438A, Alexandra Road, #05-01/02
Alexandra Technopark,
Singapore 119967
Phone: (65) 271-3566
Fax: (65) 271-3855

KOREA

SHARP Electronic Components
(Korea) Corporation
RM 501 Geosung B/D, 541
Dohwa-dong, Mapo-ku
Seoul 121-701, Korea
Phone: (82) 2-711-5813 ~ 8
Fax: (82) 2-711-5819

CHINA

SHARP Microelectronics of China
(Shanghai) Co., Ltd.
28 Xin Jin Qiao Road King Tower 16F
Pudong Shanghai, 201206 P.R. China
Phone: (86) 21-5854-7710/21-5834-6056
Fax: (86) 21-5854-4340/21-5834-6057

Head Office:

No. 360, Bashen Road,
Xin Development Bldg. 22
Waigaoqiao Free Trade Zone Shanghai
200131 P.R. China
Email: smc@china.global.sharp.co.jp

HONG KONG

SHARP-ROXY (Hong Kong) Ltd.
3rd Business Division,
17/F, Admiralty Centre, Tower 1
18 Harcourt Road, Hong Kong
Phone: (852) 28229311
Fax: (852) 28660779
www.sharp.com.hk

Shenzhen Representative Office:

Room 13B1, Tower C,
Electronics Science & Technology Building
Shen Nan Zhong Road
Shenzhen, P.R. China
Phone: (86) 755-3273731
Fax: (86) 755-3273735